

Conductive Sensors 2 to 4-point level controller Type CL with potentiometer

CARLO GAVAZZI



- Conductive level controller
- Adjustment of sensitivity – operating resistance from 250Ω to 500KΩ
- Multiple combinations of filling and emptying applications
- Low-voltage AC electrodes
- Easy installation on DIN rails or with 11 pin circular plug
- Rated operational voltage:
24 VAC/DC, 115 VAC or 230 VAC
- Output 2x8A/250 VAC SPDT relay
- LED indication for: Output ON and Power ON



Product Description

μ-Processor based level controller for liquids with a wide sensitivity range (like sewage water, chemicals, salt water etc.). The controller has a separate output for alarm indication in case of a tank running dry or if an overflow condition occurs.
8A SPDT/SPST relay output, NO/NC.
Sensitivity control by potentiometer level in 3 ranges.

Ordering Key

CLD4MA2DM24

Type _____
 DIN rail mounting _____
 Inputs _____
 Function _____
 Adjustment _____
 Outputs _____
 Relay versions _____
 Power supply _____

Type Selection

Mounting	Relay	Ordering no. Supply: 24 VAC/DC	Ordering no. Supply: 115 VAC	Ordering no. Supply: 230 VAC
DIN-rail	SPDT + SPST	CLD4MA2DM24	CLD4MA2D115	CLD4MA2D230
11-p circular plug	2 SPST	CLP4MA2AM24	CLP4MA2A115	CLP4MA2A230

Specifications

Rated operational voltage (U_B) Pin 2 & 10	230 115	195 to 265 VAC, 45 to 65 Hz 98 to 132 VAC, 45 to 65 Hz	Ranges S (Standard sensitivity) Ranges H (High sensitivity)	5 KΩ to 100 KΩ, C _F = 2.2 nF* 50 KΩ to 500 KΩ, C _F = 1.0 nF*
Supply class 2	24	19.2 to 28.8 VAC/DC	Dielectric voltage	>2.0 KVAC (rms) (contacts / electronics)
Rated insulation voltage		<2.0 kVAC (rms)	Rated impulse withstand volt.	4 kV (1.2/50 μs) (contacts / electronics) (IEC 664)
Rated impulse withstand voltage		4 kV (1.2/50 μs) (line/neutral)	Operating frequency (f) Relay output	0.5 HZ
Rated operational power AC supply AC/DC supply	5 VA 5 VA / 5 W		Response time OFF-ON (t _{on}) ON-OFF (t _{off})	1 s 1 s
Delay on operate (t_v)	< 300 mS		Environment Overvoltage category Degree of protection Pollution degree	III (IEC 60664) IP 20 /IEC 60529, 60947-1) 2 (IEC 60664/60664A, 60947-1)
Outputs Rated insulation voltage		Make or break on rotary-switch 250 VAC (rms) (cont./elec.)	Temperature Operating Storage	-20° to +50°C (-4° to + 122°F) -50° to +85°C (-58° to +185°F)
Relay Rating (AgCdO) Resistive loads	AC1 DC1	μ (micro gap) 8 A / 250 VAC (2500 VA) 1 A / 250 VDC (250 W) or 10 A 25 VDC (250 W)	Housing material	CLP CLD
Small induc. Loads	AC15 DC13	0,4 A 250 VAC 0,4 A / 30 VDC	Weight AC supply AC/DC supply	NORYL PPO, light grey ABS VO, light grey
Mechanical life (typical)		≥ 30 x 10 ⁶ operations @ 18'000 imp/h	UL Approvals	cULus UL508, UL325, CSA-C22.2 No.247
Electrical life (typical)	AC1	> 250'000 operations	CE marking	Yes
Level probe supply		Max. 5 VAC		
Level probe current		Max. 2 mA		
Sensitivity		250Ω to 500KΩ Factory settings standard range "S" 100KΩ 250 Ω to 5 KΩ, C _F = 4.7 nF*		
Ranges L (Low sensitivity)				

*C_F = maximum Cable Capacitance



Mode of Operation

Connection cable

2, 3, 4 or 5 conductor PVC cable, normally screened. Cable length: max. 100 m. The resistance between the cores and the ground must be at least 500k. Normally, it is recommended to use a screened cable between probe and controller, e.g. where the cable is placed in parallel to the load cables (mains). The screen has to be connected to Y5 (reference).

Example 1

The diagram shows the level control connected as max. and min. control, i.e. registration of 2 levels + 2 alarm levels. The relays

react to the low current created when the electrodes are in contact with the liquid.

The reference (Ref) must be connected to the container or if the container consists of a non-conductive material, to an additional electrode. (To be connected to pin Y5).

In the diagram this electrode is shown by the dotted line.)

The alarm outputs utilize alarm - and Y1 for LoLo alarm - and Y4 for HiHi alarm outputs.

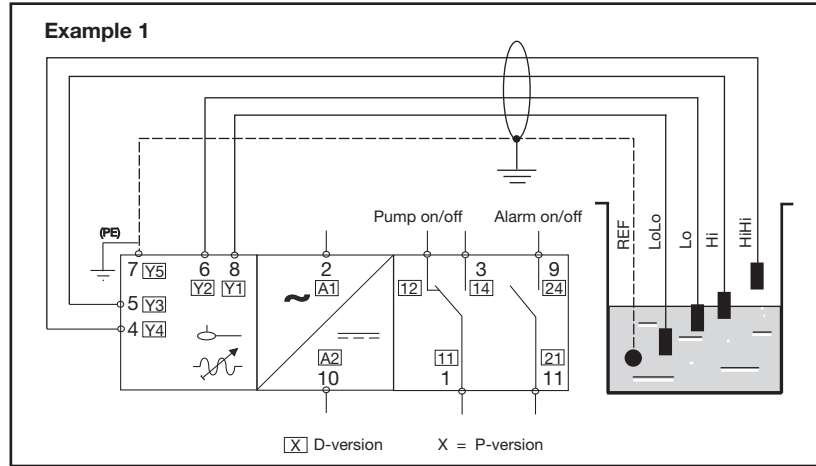

Operation Diagram

Function: Filling or Emptying

The Multifunction Controller can be used as a minimum-maximum control for two systems, a filling system and an emptying system, with the same kind of liquid to be measured and one common pump.

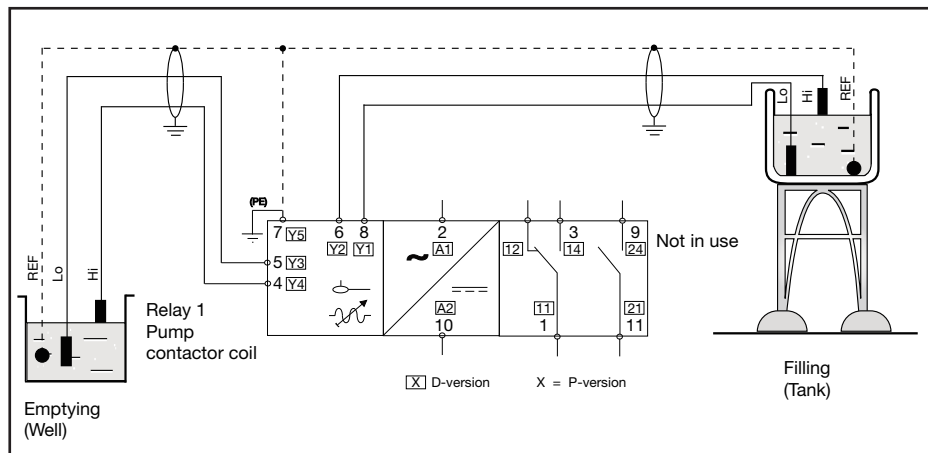

Tank-Well application (Filling and emptying)

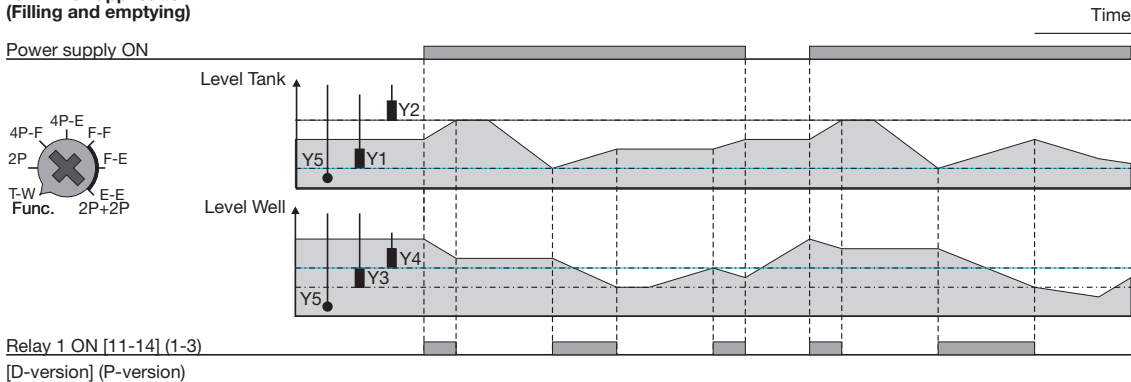

Operation Diagram

Function: Direct input- output
 The Multifunction Controller can be used as direct input/ output, where each of the two inputs (electrodes) controls an individual relay output:
 Electrode no. 1 = Relay no. 1
 Electrode no. 2 = Relay no. 2.

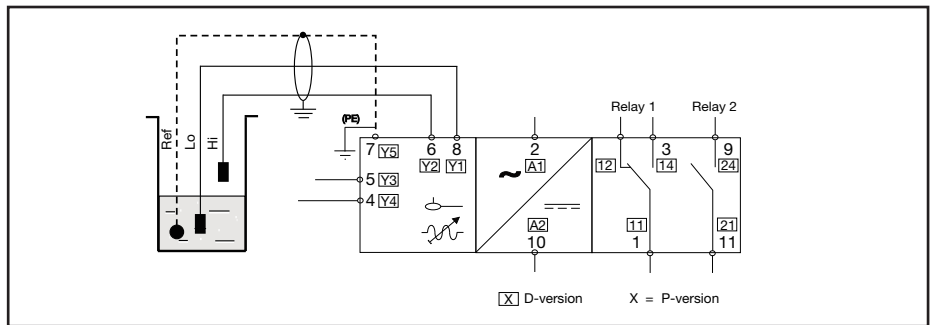

2-Probe (Direct Input to output)

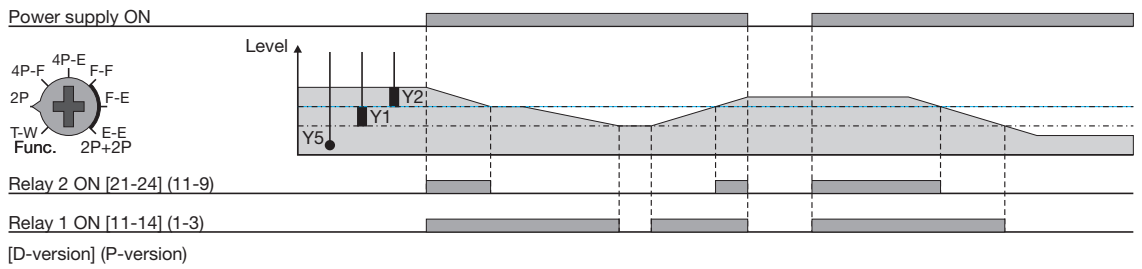

Function: Filling or Emptying with high and low alarms
 The Multifunction Controller can be used as a minimum-maximum control filling or emptying system, with HiHi and LoLo Alarm output.

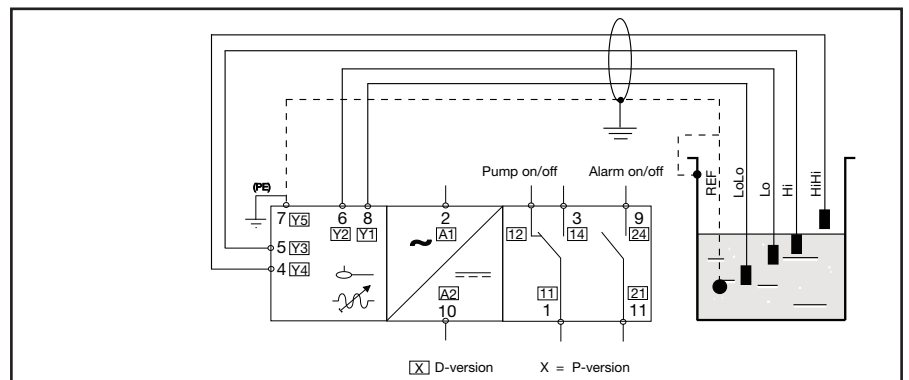

4-Probe Filling (Low and High alarm)

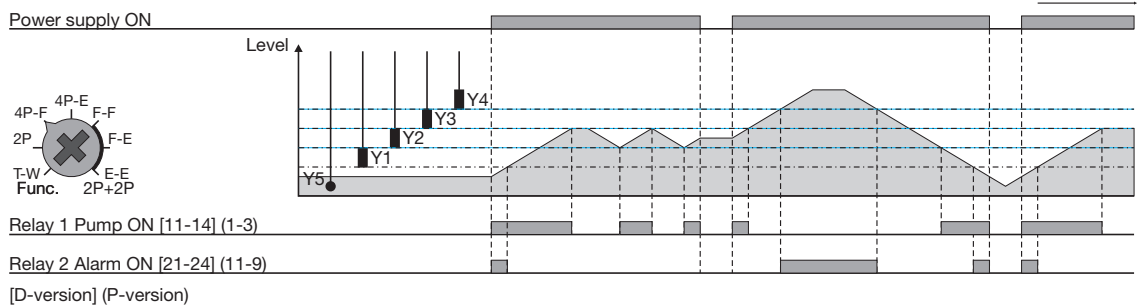

4-Probe Emptying (Low and High alarm)

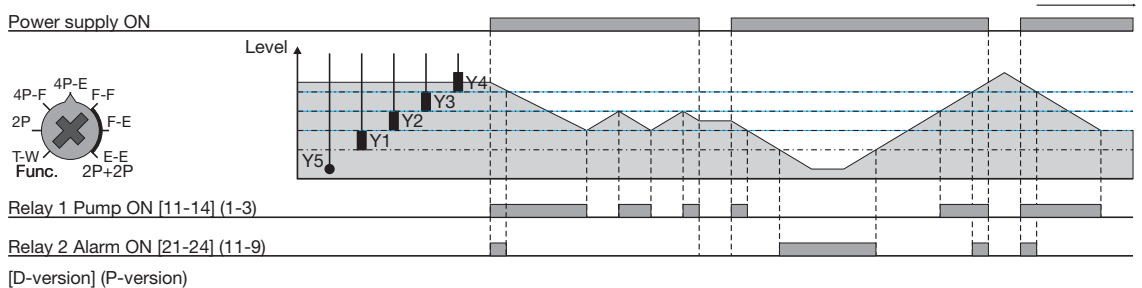

Operation Diagram

Function: Filling or Emptying
 The Multifunction Controller can be used as a minimum-maximum control for up to two individual systems, with the same kind of liquid to be measured.

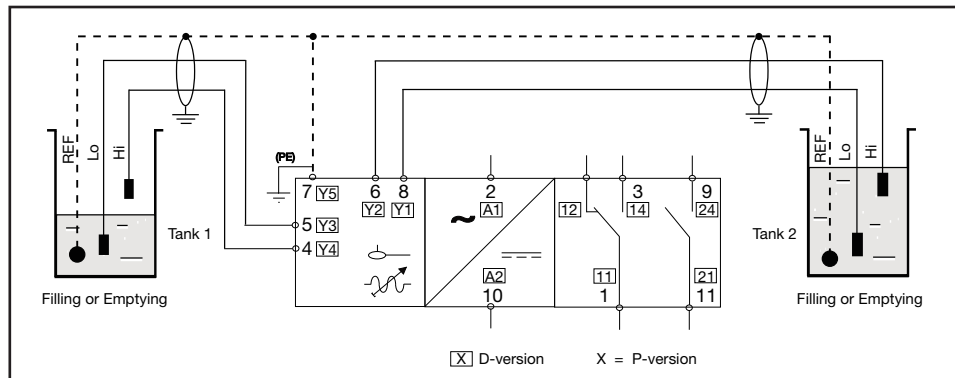

2 Individual systems (Filling and/or emptying)

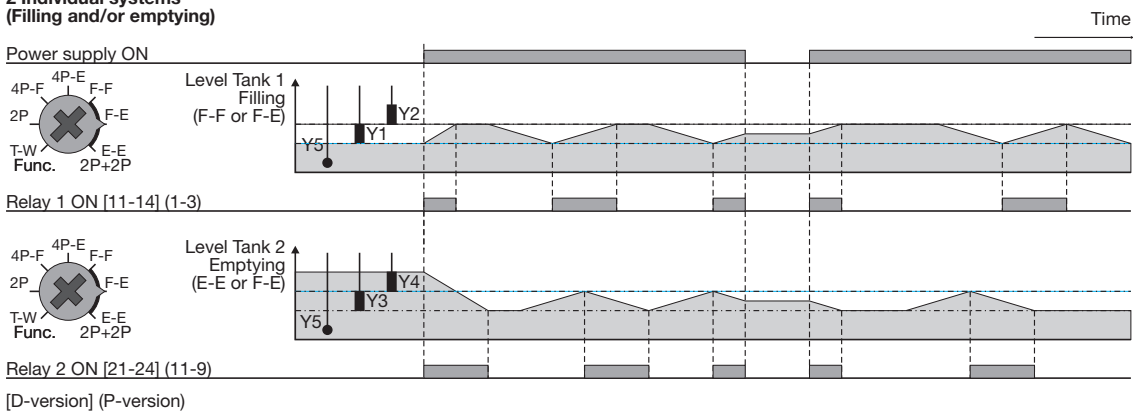

Wiring Diagram

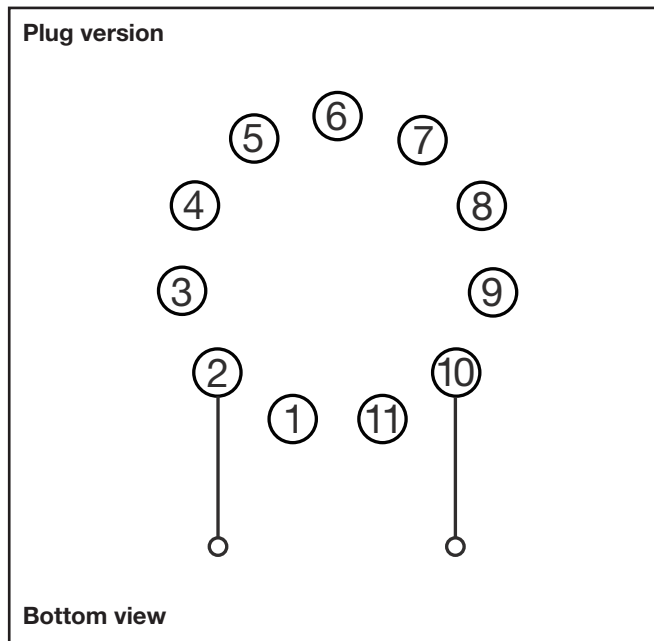
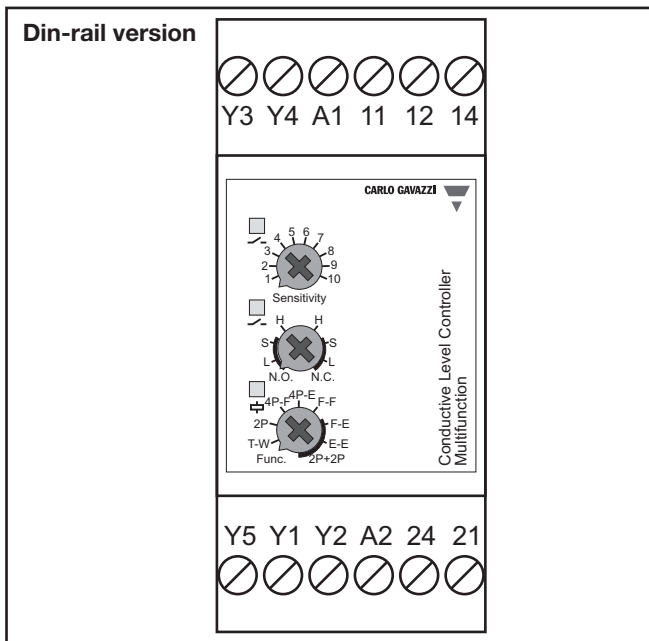

Dimension Drawings

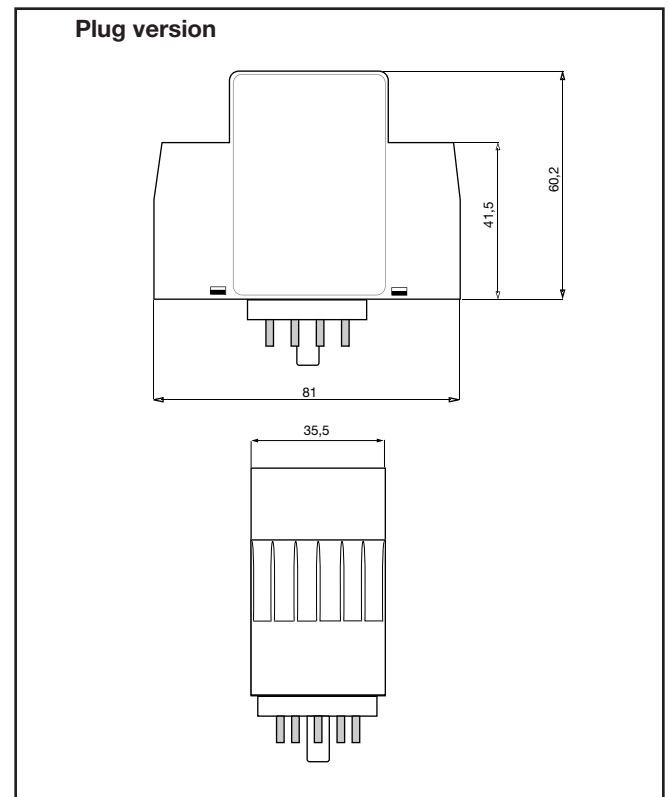
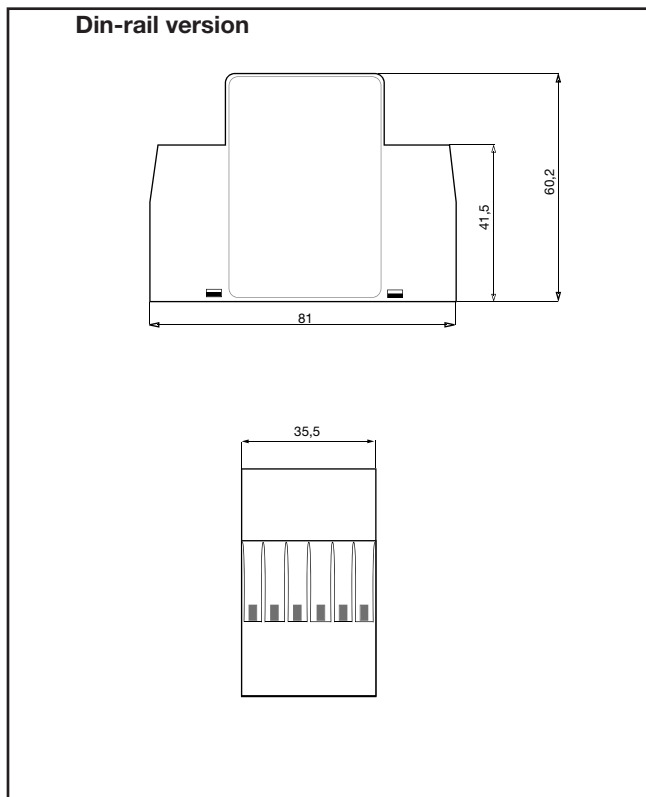

Accessories

- 11 pole circular socket ZPD11
- Retaining spring HF

Delivery Contents

- Amplifier
- Packaging: Carton box
- Manual